

ActionJac EM2.5-MSJ-I 24:1

Call 800-321-7800 or visit us online at www.nookindustries.com to configure and order your ActionJac EM2.5-MSJ-I 24:1 today!

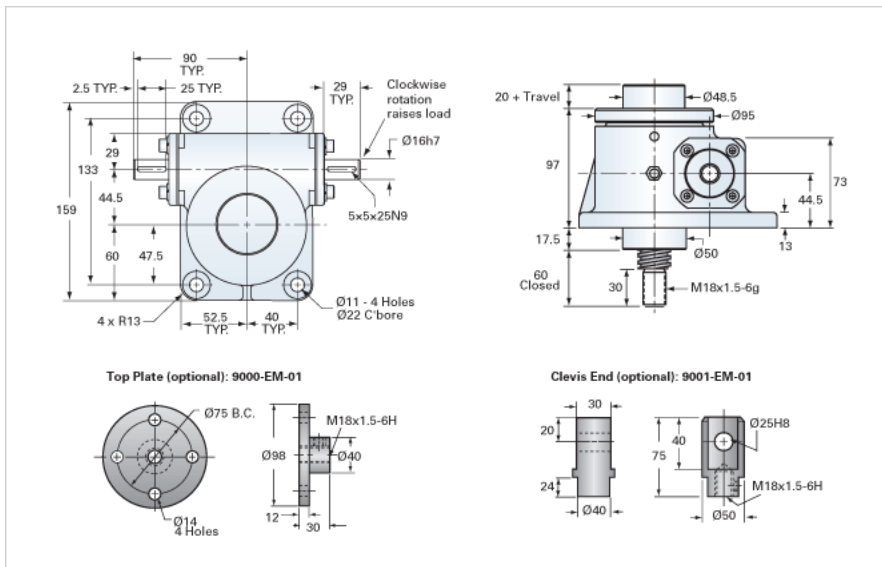

Details

Capacity [kN]	25
Gear Ratio	24:1
Travel for 1 Turn of Worm [mm]	0.25
Torque to Raise 1 kN [Nm]	0.25
No Load Torque [Nm]	0.56
Lifting Screw Diameter [mm]	26
Screw Lead [mm]	6
Root Diameter [mm]	17.8

Performance Specifications

Maximum Allowable Input [kW]	0.38
Maximum Input Torque [Nm]	6.30
Maximum Load at 1425 RPM [kN]	10.1
Maximum Worm Speed at Rated Load [rpm]	575
Starting Torque	2 x Running Torque

Weight

Base 0 Travel [kg]	7.70
Per 100mm of Travel [kg]	0.32
Grease [kg]	0.22