

## ActionJac EM1-MSJ-I 20:1

Call 800-321-7800 or visit us online at [www.nookindustries.com](http://www.nookindustries.com) to configure and order your ActionJac EM1-MSJ-I 20:1 today!

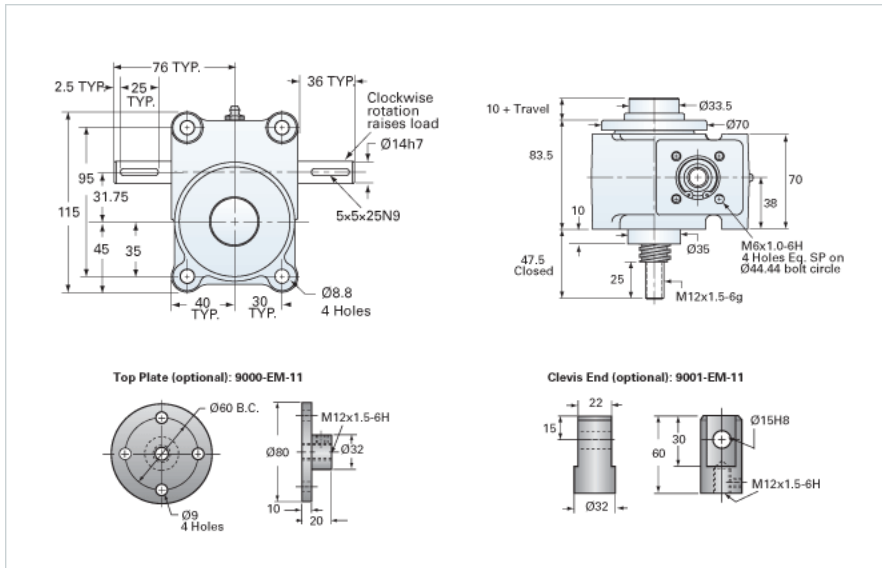

### Details

Capacity [kN]	10
Gear Ratio	20:1
Travel for 1 Turn of Worm [mm]	0.2
Torque to Raise 1 kN [Nm]	0.24
No Load Torque [Nm]	0.34
Lifting Screw Diameter [mm]	20
Screw Lead [mm]	4
Root Diameter [mm]	14.9

### Performance Specifications

Maximum Allowable Input [kW]	0.19
Maximum Input Torque [Nm]	2.44
Maximum Load at 1425 RPM [kN]	5.1
Maximum Worm Speed at Rated Load [rpm]	730
Starting Torque	2 x Running Torque

### Weight

Base 0 Travel [kg]	2.50
Per 100mm of Travel [kg]	0.19
Grease [kg]	0.23