

## ActionJac EM5-MSJ-IR 24:1

Call 800-321-7800 or visit us online at [www.nookindustries.com](http://www.nookindustries.com) to configure and order your ActionJac EM5-MSJ-IR 24:1 today!

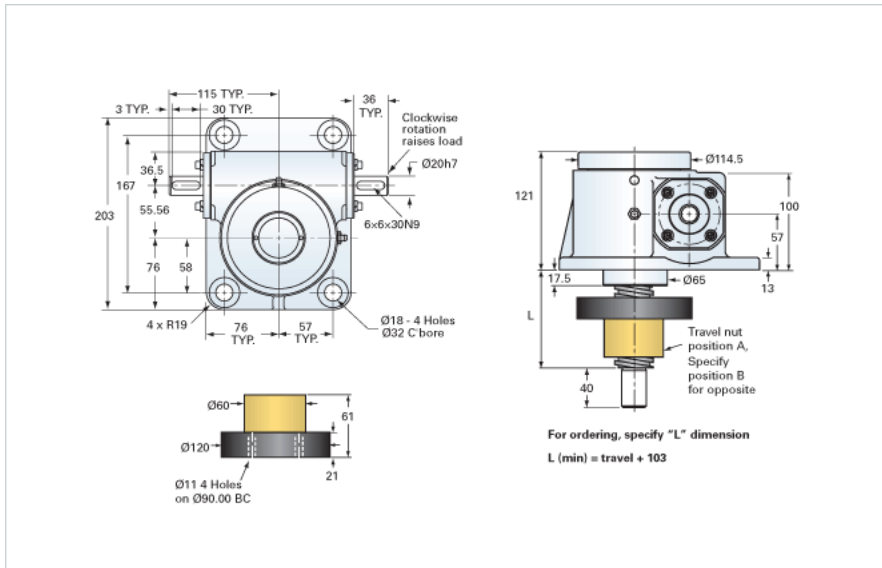

### Details

Capacity [kN]	50
Gear Ratio	24:1
Travel for 1 Turn of Worm [mm]	0.29
Torque to Raise 1 kN [Nm]	0.32
No Load Torque [Nm]	1.13
Lifting Screw Diameter [mm]	40
Screw Lead [mm]	7
Root Diameter [mm]	30.9

### Performance Specifications

Maximum Allowable Input [kW]	0.51
Maximum Input Torque [Nm]	16.00
Maximum Load at 1425 RPM [kN]	10.7
Maximum Worm Speed at Rated Load [rpm]	300
Starting Torque	2 x Running Torque

### Weight

Base 0 Travel [kg]	13.60
Per 100mm of Travel [kg]	0.81
Grease [kg]	0.45