

## ActionJac EM20-BSJ-UR 24:1

Call 800-321-7800 or visit us online at [www.nookindustries.com](http://www.nookindustries.com) to configure and order your ActionJac EM20-BSJ-UR 24:1 today!

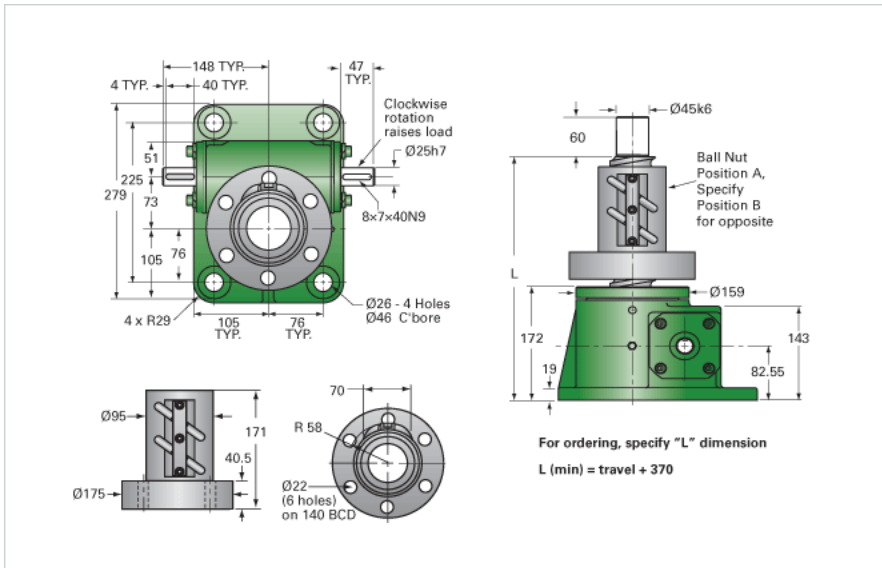

### Details

Capacity [kN]	200
Gear Ratio	24:1
Raise for One Turn of Worm [mm]	0.50
Torque to Raise 1 kN [Nm]	0.19
No Load Torque [Nm]	4.52
Lifting Screw Diameter [mm]	63
Screw Lead [mm]	12
Root Diameter [mm]	57.0
BackDrive Holding Torque [Nm]	31.0

### Performance Specifications

Maximum Allowable Input [kW]	1.90
Maximum Input Torque [Nm]	37.70
Maximum Load at 1425 RPM [kN]	66.1
Maximum Worm Speed at Rated Load [rpm]	410
Starting Torque	1.5 x Running Torque

### Weight

Base 0 Travel [kg]	38.60
Per 100mm of Travel [kg]	2.31
Grease [kg]	1.00