

ActionJac EM10-BSJ-UR 24:1

Call 800-321-7800 or visit us online at www.nookindustries.com to configure and order your ActionJac EM10-BSJ-UR 24:1 today!

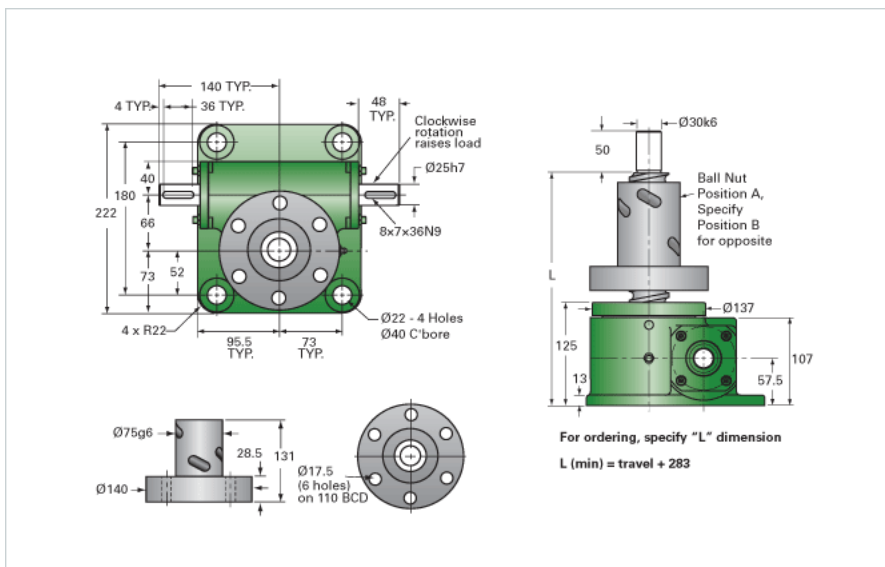

Details

Capacity [kN]	100
Gear Ratio	24:1
Raise for One Turn of Worm [mm]	0.42
Torque to Raise 1 kN [Nm]	0.16
No Load Torque [Nm]	2.26
Lifting Screw Diameter [mm]	50
Screw Lead [mm]	10
Root Diameter [mm]	45.2
BackDrive Holding Torque [Nm]	13.5

Performance Specifications

Maximum Allowable Input [kW]	1.12
Maximum Input Torque [Nm]	16.20
Maximum Load at 1425 RPM [kN]	46.6
Maximum Worm Speed at Rated Load [rpm]	665
Starting Torque	1.5 x Running Torque

Weight

Base 0 Travel [kg]	22.70
Per 100mm of Travel [kg]	1.46
Grease [kg]	0.69