

## ActionJac 20AB-MSJ-U 8:1

Call 800-321-7800 or visit us online at [www.nookindustries.com](http://www.nookindustries.com) to configure and order your ActionJac 20AB-MSJ-U 8:1 today!

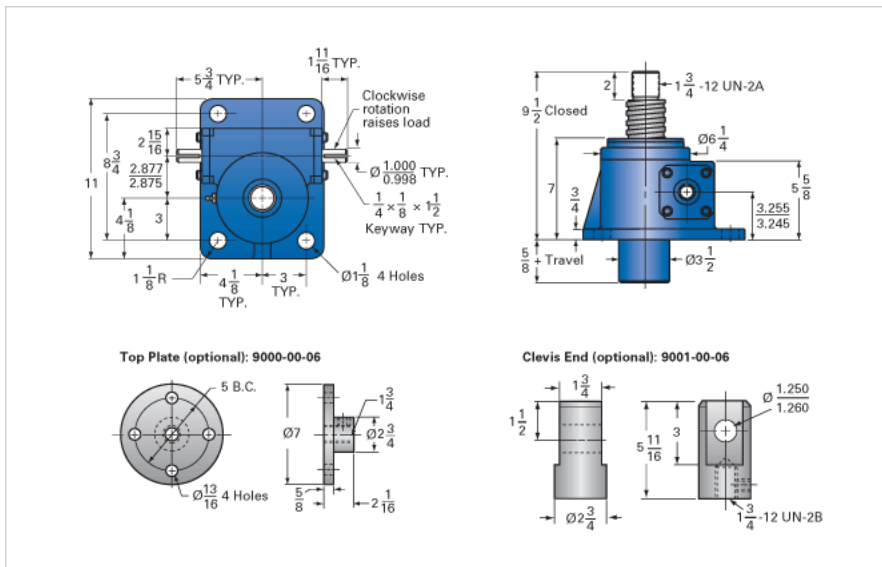

### Details

Capacity [Ton]	20
Gear Ratio	8:1
Turns of Worm per Inch Travel	16
Torque to Raise 1 lb. [in-lb]	0.0435
Lifting Screw Diameter [in]	2.50
Screw Lead [in]	0.500
Root Diameter [in]	1.908
Tare Drag Torque [in-lb]	40

### Performance Specifications

Maximum Allowable Input [hp]	7.50
Maximum Input Torque [in-lb]	1740
Maximum Worm Speed at Rated Load [rpm]	272
Maximum Load at 1750 RPM [lb]	6209
Starting Torque	2 x Running Torque

### Weight

Base 0 Travel [lb]	80
Per Inch of Travel [lb]	1.80
Grease [lb]	2.3