

ActionJac 5AB-MSJ-U 24:1

Call 800-321-7800 or visit us online at www.nookindustries.com to configure and order your ActionJac 5AB-MSJ-U 24:1 today!

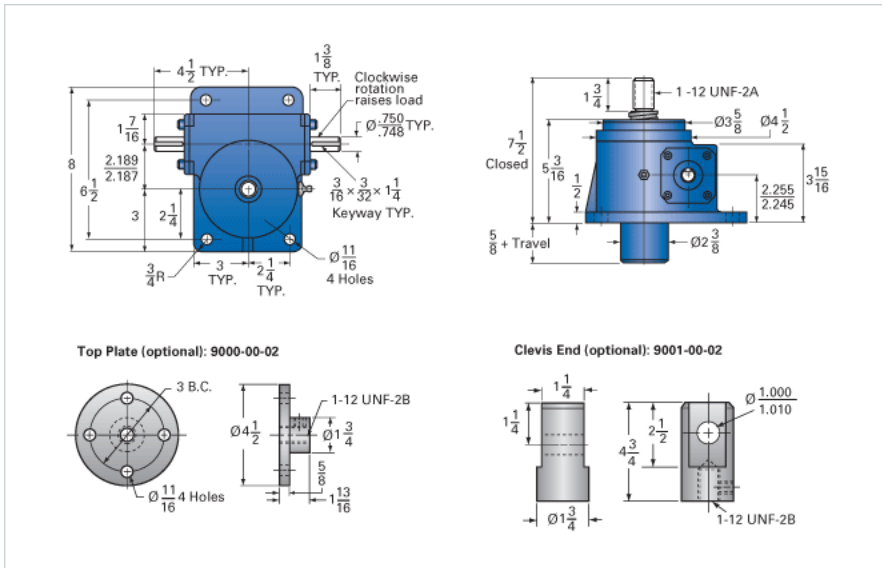

Details

Capacity [Ton]	5
Gear Ratio	24:1
Turns of Worm per Inch Travel	64
Torque to Raise 1 lb. [in-lb]	0.0144
Lifting Screw Diameter [in]	1.50
Screw Lead [in]	0.375
Root Diameter [in]	1.066
Tare Drag Torque [in-lb]	10

Performance Specifications

Maximum Allowable Input [hp]	0.75
Maximum Input Torque [in-lb]	144
Maximum Worm Speed at Rated Load [rpm]	330
Maximum Load at 1750 RPM [lb]	1875
Starting Torque	2 x Running Torque

Weight

Base 0 Travel [lb]	30
Per Inch of Travel [lb]	0.70
Grease [lb]	1.0