

## ActionJac 50-MSJ-IR 32:1

Call 800-321-7800 or visit us online at [www.nookindustries.com](http://www.nookindustries.com) to configure and order your ActionJac 50-MSJ-IR 32:1 today!

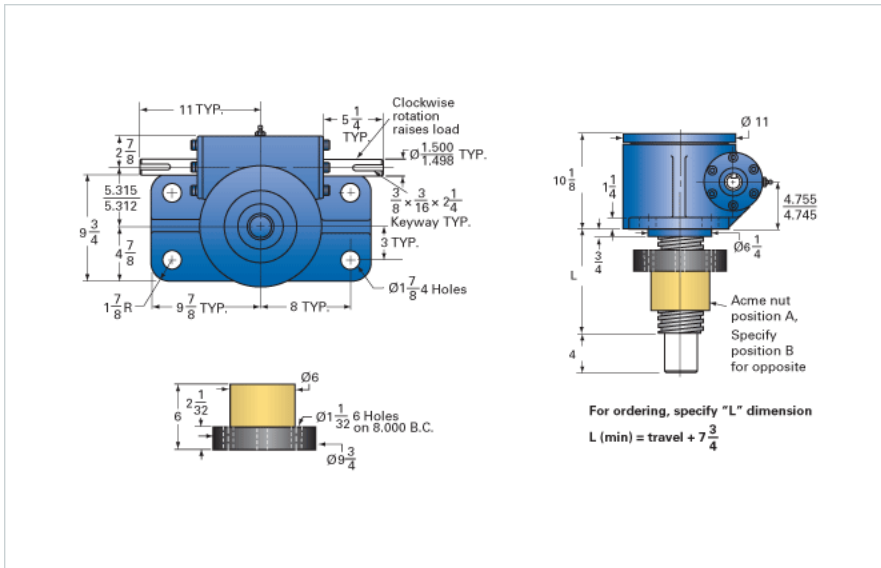

### Details

Capacity [Ton]	50
Gear Ratio	32:1
Turns of Worm per Inch Travel	48
Torque to Raise 1 lb. [in-lb]	0.0301
Lifting Screw Diameter [in]	4.50
Screw Lead [in]	0.667
Root Diameter [in]	3.782
Tare Drag Torque [in-lb]	100

### Performance Specifications

Maximum Allowable Input [hp]	5.00
Maximum Input Torque [in-lb]	3014
Maximum Worm Speed at Rated Load [rpm]	104
Maximum Load at 1750 RPM [lb]	5982
Starting Torque	2 x Running Torque

### Weight

Base 0 Travel [lb]	280
Per Inch of Travel [lb]	5.00
Grease [lb]	5.8