

ActionJac 50-MSJ-IK 10 2/3:1

Call 800-321-7800 or visit us online at www.nookindustries.com to configure and order your ActionJac 50-MSJ-IK 10 2/3:1 today!

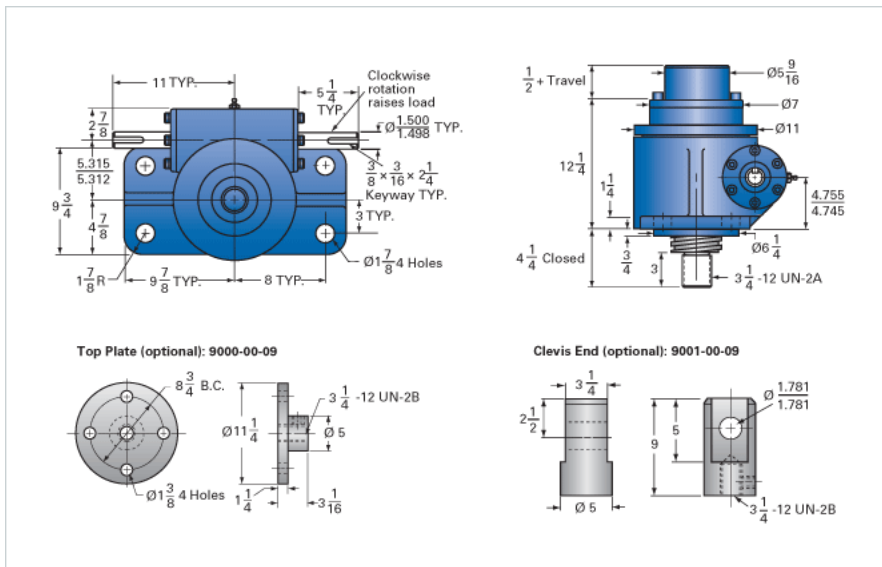

Details

Capacity [Ton]	50
Gear Ratio	10 2/3:1
Turns of Worm per Inch Travel	16
Torque to Raise 1 lb. [in-lb]	0.0638
Lifting Screw Diameter [in]	4.50
Screw Lead [in]	0.667
Root Diameter [in]	3.782
Tare Drag Torque [in-lb]	100

Performance Specifications

Maximum Allowable Input [hp]	16.00
Maximum Input Torque [in-lb]	5555
Maximum Worm Speed at Rated Load [rpm]	158
Maximum Load at 1750 RPM [lb]	9032
Starting Torque	2 x Running Torque

Weight

Base 0 Travel [lb]	280
Per Inch of Travel [lb]	5.00
Grease [lb]	5.8