

NH65LER

Call 800-321-7800 or visit us online at www.nookindustries.com to configure and order your NH65LER today!

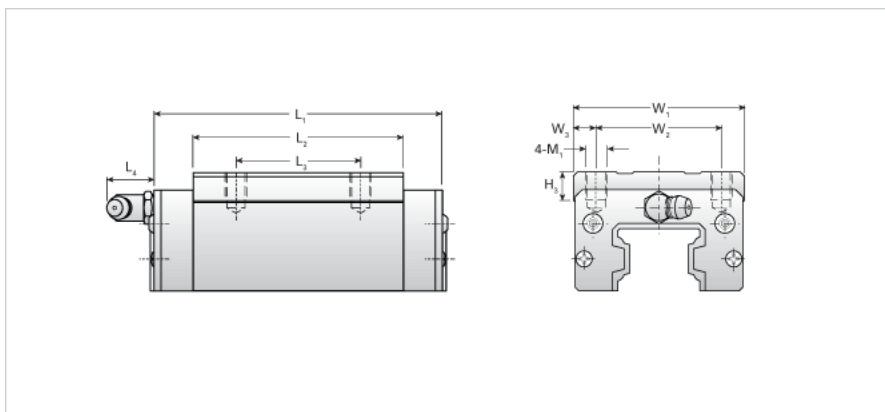

Details	
Size [mm]	65
Dimensions	
L1 [mm]	257
L2 [mm]	207
L3 [mm]	120
L4 [mm]	16
M1 x l	M16x20
H3 [mm]	23
W1 [mm]	126
W2 [mm]	90
W3 [mm]	18
Forces and Torques	
Basic Load Ratings C [kN]	192.11
Basic Load Ratings C [lbf]	43175
Basic Load Ratings C0 [kN]	286.15
Basic Load Ratings C0 [lbf]	64310
Static Moment Ratings-Ma [kN-m]	7.21
Static Moment Ratings-Ma [lb-in]	63798
Static Moment Ratings-Mb [kN-m]	7.21
Static Moment Ratings-Mb [lb-in]	63798
Static Moment Ratings-Mc [kN-m]	10.75
Static Moment Ratings-Mc [lb-in]	95133
Weight	
Weight-Block [kg]	10.50
Grease Fitting	
Grease Fitting Part Number	B-PT 1/8