

QLR 60

Call 800-321-7800 or visit us online at www.nookindustries.com to configure and order your QLR 60 today!

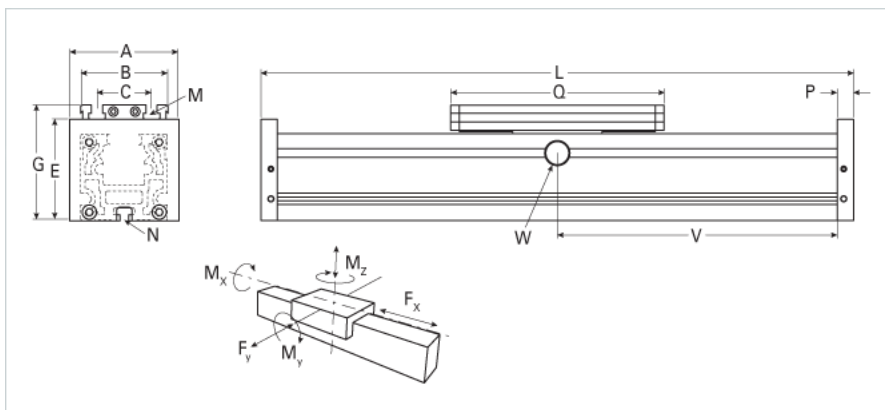
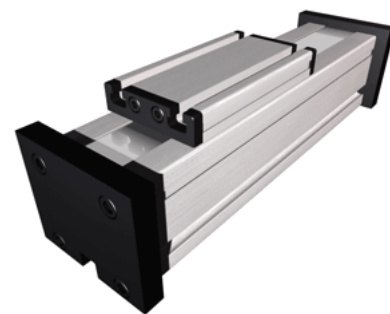

Details	
Size	60
Dimensions	
Basic Length L [mm]	180
A [mm]	80
B [mm]	60
C [mm]	36
E [mm]	60
G [mm]	79
M	M6
N	M5
P [mm]	12
Q [mm]	152
Speed	
Speed Maximum [m/s]	4
Forces and Torques	
Fx dynamic [N]	-
Fy dynamic [N]	500
Fz dynamic [N]	650
Mx dynamic [Nm]	10
My dynamic [Nm]	50
Mz dynamic [Nm]	30
Fx static [N]	-
Fy static [N]	600
Fz static [N]	900
Mx static [Nm]	15
My static [Nm]	60
Mz static [Nm]	40
Geometrical moments of inertia of aluminum profile	
Elastic modulus [N/mm ²]	70000
Ix [mm ⁴]	430000
Iy [mm ⁴]	480000
Weight	
Additional Weight per 100 mm [kg]	0.36
Basic Weight [kg]	1.5