

QSR 60

Call 800-321-7800 or visit us online at www.nookindustries.com to configure and order your QSR 60 today!

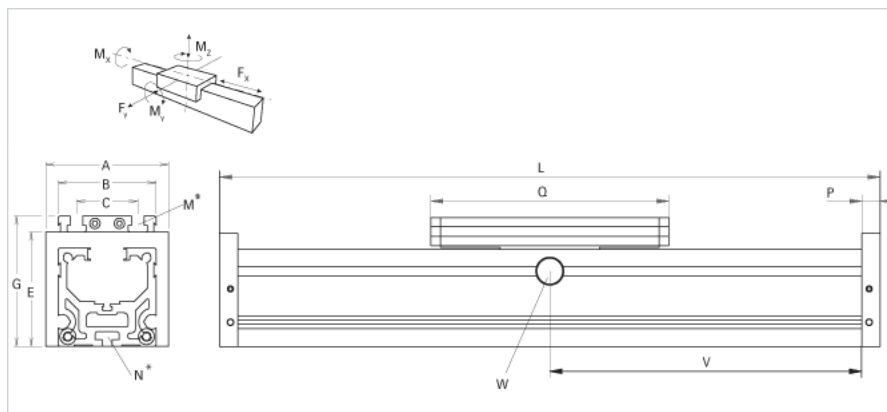

Details	
Size	60
Dimensions	
Basic Length L [mm]	205
A [mm]	80
B [mm]	60
C [mm]	36
E [mm]	60
G [mm]	79
M	M6
N	M5
P [mm]	12
Q [mm]	177
Speed	
Speed Maximum [m/s]	5
Forces and Torques	
F _x [N] 10000 km	-
F _y [N] 10000 km	990
F _z [N] 10000 km	2500
M _x [Nm] 10000 km	23
M _y [Nm] 10000 km	73
M _z [Nm] 10000 km	70
F _x [N] 5000 km	-
F _y [N] 5000 km	1410
F _z [N] 5000 km	3520
M _x [Nm] 5000 km	33
M _y [Nm] 5000 km	104
M _z [Nm] 5000 km	100
Geometrical moments of inertia of aluminum profile	
Elastic modulus [N/mm ²]	70000
I _x [mm ⁴]	430000
I _y [mm ⁴]	480000
Weight	
Additional Weight per 100 mm [kg]	0.50
Basic Weight [kg]	1.8