

## QSK 100 Dual Carriage

Call 800-321-7800 or visit us online at [www.nookindustries.com](http://www.nookindustries.com) to configure and order your QSK 100 Dual Carriage today!

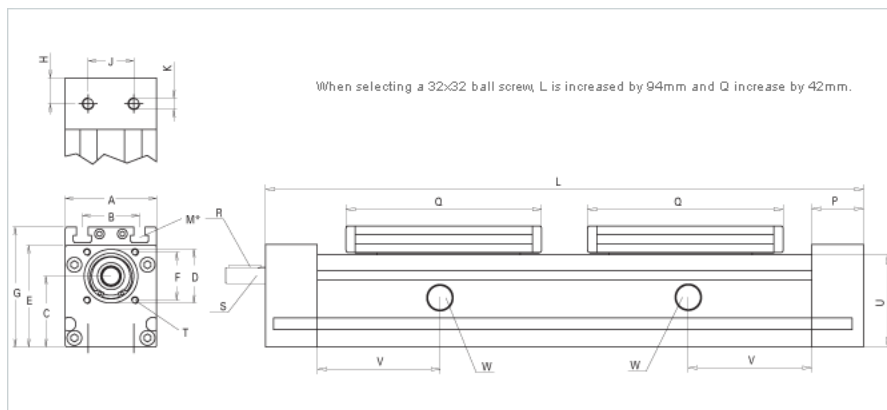
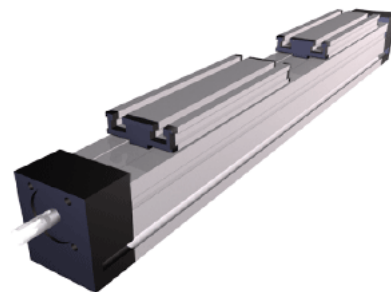

Details	
Size	100
Dimensions	
Basic Length L with Divided Screw [mm]	740
Basic Length L with Twin Lead Screw [mm]	700
A [mm]	100
B [mm]	66
C [mm]	75
D [mm]	68
E [mm]	112
F [mm]	60
G [mm]	129
H [mm]	28.5
J [mm]	50
K	M10
M	M10
P [mm]	57
Q [mm]	288
Shaft R Key [mm]	6x6x40
Shaft S Diameter x Length [mm]	22h6x45
T	M8
U [mm]	100
Forces and Torques	
Fx [N] 10000 km	4000
Fy [N] 10000 km	2910
Fz [N] 10000 km	7360
Mx [Nm] 10000 km	101
My [Nm] 10000 km	597
Mz [Nm] 10000 km	532
Fx [N] 5000 km	5000
Fy [N] 5000 km	4082
Fz [N] 5000 km	10300
Mx [Nm] 5000 km	142
My [Nm] 5000 km	838
Mz [Nm] 5000 km	745
Geometrical moments of inertia of aluminum profile	
Elastic modulus [N/mm <sup>2</sup> ]	70000
Ix [mm <sup>4</sup> ]	4300000
Iy [mm <sup>4</sup> ]	4880000
Weight	
Additional Weight per 100 mm [kg]	1.3
Basic Weight [kg] [.0]	18.6