

QST 80

Call 800-321-7800 or visit us online at www.nookindustries.com to configure and order your QST 80 today!

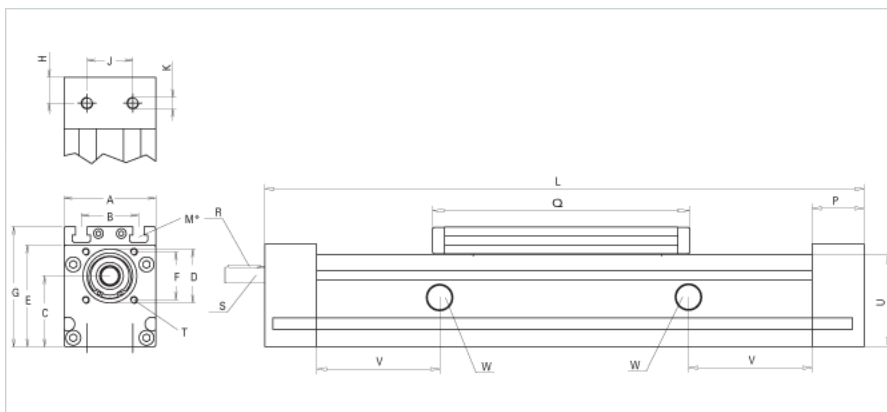
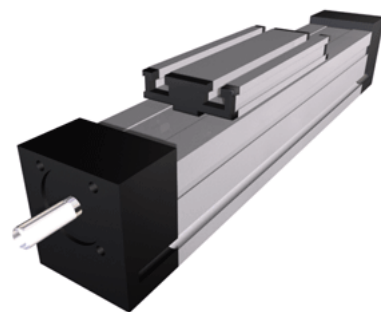

Details

Size	80
Screw Options	24x5/24x10
Screw Type	Trapexoidal

Dimensions

Basic Length L [mm]	350
A [mm]	80
B [mm]	50
C [mm]	62
D [mm]	47
E [mm]	89
F [mm]	42
G [mm]	106
H [mm]	22.5
J [mm]	40
K	M10
M	M8
P [mm]	45
Q [mm]	250
Shaft R Key [mm]	5x5x28
Shaft S Diameter x Length [mm]	14h6x35
T	M6
U [mm]	80

Forces and Torques

Fx [N] 10000 km	2000
Fy [N] 10000 km	2542
Fz [N] 10000 km	6050
Mx [Nm] 10000 km	76
My [Nm] 10000 km	430
Mz [Nm] 10000 km	392
Fx [N] 5000 km	2500
Fy [N] 5000 km	3570
Fz [N] 5000 km	8500
Mx [Nm] 5000 km	107
My [Nm] 5000 km	604
Mz [Nm] 5000 km	550

Geometrical moments of inertia of aluminum profile

Elastic modulus [N/mm ²]	70000
Ix [mm ⁴]	1400000
Iy [mm ⁴]	1660000

Weight

Weight Per 100 mm [kg]	0.9
Basic Weight [kg]	7.5