

ELZU 30

Call 800-321-7800 or visit us online at www.nookindustries.com to configure and order your ELZU 30 today!

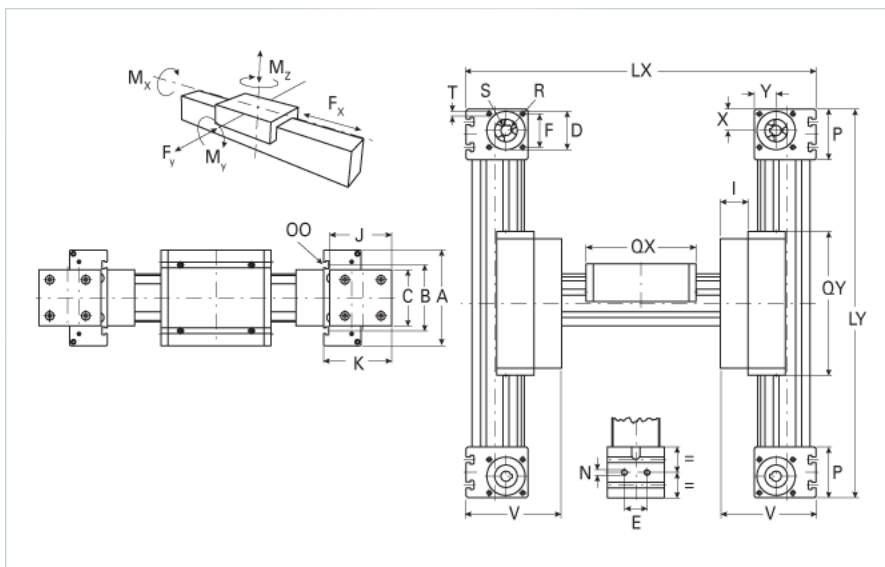

Details

Size	30
Belt	3M12
mm/Rev	75
Number of Teeth	25

Dimensions

Basic length Lx [mm]	240
Basic length Ly [mm]	210
A [mm]	70
B [mm]	56
C [mm]	42
D [mm]	28
E [mm]	13
F [mm]	25
G [mm]	-
H [mm]	-
I [mm]	27
J [mm]	44
K [mm]	47
MM	-
N	M5
OO	M6
P [mm]	36
Qx [mm]	82
Qy [mm]	126
T	M5
V [mm]	74
X [mm]	16
Y [mm]	16
Shaft Diameter and Length [mm]	6 x 15
Key	2x2x12

Speed

Speed Maximum [m/s]	2
---------------------	---

Forces and Torques

No-load torque [Nm]	0.2
Tensile force 0.2 sec [N]	280
Tensile force permanent [N]	200
Fx dynamic [N]	180
Fy dynamic [N]	60
Fz dynamic [N]	60
Mx dynamic [Nm]	5
My dynamic [Nm]	6
Mz dynamic [Nm]	7
Fx static [N]	200
Fy static [N]	90
Fz static [N]	90
Mx static [Nm]	10
My static [Nm]	13

Mz static [Nm]	14
Geometrical moments of inertia of aluminum profile	
Elastic modulus [N/mm ²]	70000
Ix [mm ⁴]	40900
Iy [mm ⁴]	40900
Weight	
Additional Weight per 100 mm [kg]	0.13
Basic Weight [kg]	6.3
Values for Calculating Inertias	
Pulley Material	Steel
Pulley Diameter [mm]	23.87
Effective Pulley Width [mm]	42
Belt Weight [kg/m]	0.037
Standard Carriage Weight [kg]	0.18
No-load torque [Nm]	0.2
Friction Coefficient	0.01