

## ELSZ 60

Call 800-321-7800 or visit us online at [www.nookindustries.com](http://www.nookindustries.com) to configure and order your ELSZ 60 today!

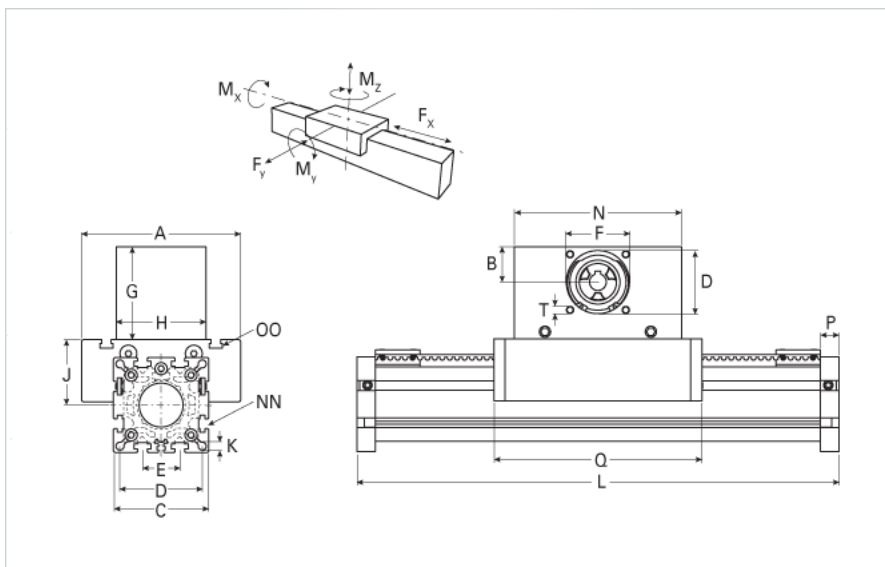
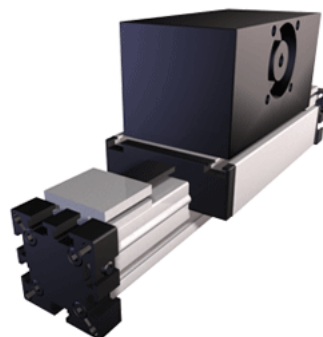

### Details

Size	60
Belt	5M25
mm/Rev	130
Number of Teeth	26

### Dimensions

Basic Length L [mm]	260
A [mm]	144
B [mm]	30
C [mm]	82
D [mm]	47
E [mm]	30
F [mm]	42
G [mm]	80
H [mm]	80
I [mm]	-
J [mm]	49
K [mm]	8.5
MM	-
N [mm]	130
NN	M8
O [mm]	69
OO	M8
P [mm]	16
Q [mm]	168
T	M6
V [mm]	-
Shaft Diameter and Length [mm]	14 x 35
Key	5x5x28

### Speed

Speed Maximum [m/s]	5
---------------------	---

### Forces and Torques

No-load torque [Nm]	0.9
Tensile force 0.2 sec [N]	1000
Tensile force permanent [N]	900
Fx dynamic [N]	800
Fy dynamic [N]	2000
Fz dynamic [N]	1100
Mx dynamic [Nm]	43
My dynamic [Nm]	70
Mz dynamic [Nm]	100
Fx static [N]	894
Fy static [N]	3000
Fz static [N]	1700
Mx static [Nm]	67
My static [Nm]	90
Mz static [Nm]	120

### Geometrical moments of inertia of aluminum profile

Elastic modulus [N/mm <sup>2</sup> ]	70000
Ix [mm <sup>4</sup> ]	679000
Iy [mm <sup>4</sup> ]	697000
<b>Weight</b>	
Additional Weight per 100 mm [kg]	0.62
Basic Weight [kg]	5.1
<b>Values for Calculating Inertias</b>	
Pulley Material - Drive Pulley (x1)	Steel
Pulley Material - Idler Pulleys (x2)	Aluminum
Pulley Diameter [mm]	41.38
Effective Pulley Width [mm]	80
Belt Weight [kg/m]	0.123
Standard Carriage Weight [kg]	1.58
No-load torque [Nm]	0.9
Friction Coefficient	0.01