

## DD-506-A3/30XX

Call 800-321-7800 or visit us online at [www.nookindustries.com](http://www.nookindustries.com) to configure and order your DD-506-A3/30XX today!

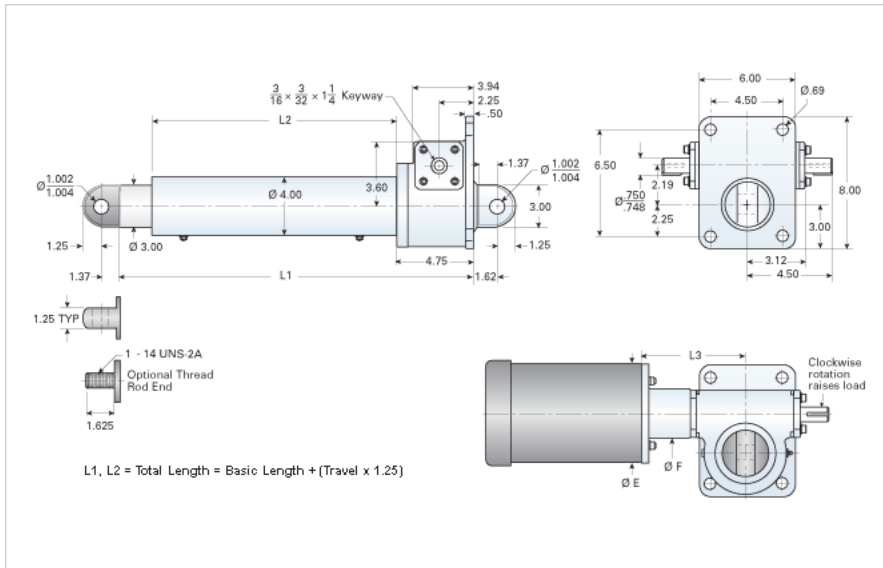

### Performance Specifications

Travel Rate [in/min]	108
Dynamic Capacity [lb]	2900
Motor Horse Power (ref.) [hp]	3
Std. Brake Torque [ft-lb]	15
Approximate Stopping Distance No Load [in]	0.28
Maximum Rod Reaction Torque [in-lb]	432

### Details

Gear Ratio	6:1
Input Turns Per Inch Of Travel	16
Torque To Raise 1 lb. [in-lb]	0.0376
Max Capacity [lb]	10000
Max HP [hp]	3

### Weight

Basic Weight [lb]	53
Per Inch of Travel [lb]	1.87

### Tube Dimensions

L1 Basic Length [in]	12.38
L2 Basic Length [in]	6.06

### NEMA 42 Dimensions

L3 [in]	-
E [in]	-
F [in]	-

### NEMA 48 Dimensions

L3 [in]	-
E [in]	-
F [in]	-

### NEMA 56C Dimensions

L3 [in]	7.25
E [in]	6.75
F [in]	3.75

### NEMA 182TC Dimensions

L3 [in]	8.00
E [in]	9.25
F [in]	3.75

### NEMA 184TC Dimensions

L3 [in]	-
E [in]	-
F [in]	-

### NEMA 213TC Dimensions

L3 [in]	-
E [in]	-
F [in]	-