

DD-506-A2/20XX

Call 800-321-7800 or visit us online at www.nookindustries.com to configure and order your DD-506-A2/20XX today!

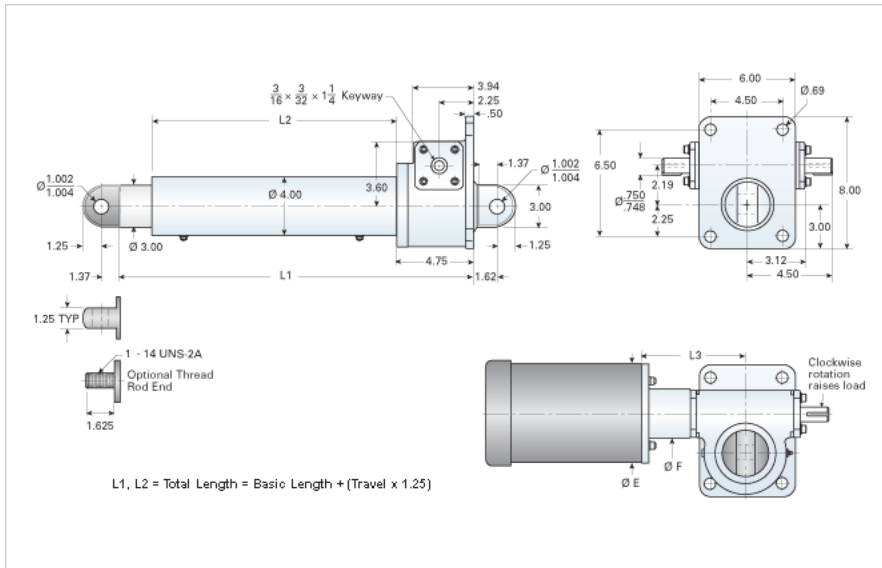

Performance Specifications

Travel Rate [in/min]	144
Dynamic Capacity [lb]	1900
Motor Horse Power (ref.) [hp]	2
Std. Brake Torque [ft-lb]	10
Approximate Stopping Distance No Load [in]	0.21
Maximum Rod Reaction Torque [in-lb]	476

Details

Gear Ratio	6:1
Input Turns Per Inch Of Travel	12
Torque To Raise 1 lb. [in-lb]	0.0437
Max Capacity [lb]	10000
Max HP [hp]	3

Weight

Basic Weight [lb]	53
Per Inch of Travel [lb]	1.87

Tube Dimensions

L1 Basic Length [in]	12.38
L2 Basic Length [in]	6.06

NEMA 42 Dimensions

L3 [in]	-
E [in]	-
F [in]	-

NEMA 48 Dimensions

L3 [in]	-
E [in]	-
F [in]	-

NEMA 56C Dimensions

L3 [in]	7.25
E [in]	6.75
F [in]	3.75

NEMA 182TC Dimensions

L3 [in]	8.00
E [in]	9.25
F [in]	3.75

NEMA 184TC Dimensions

L3 [in]	-
E [in]	-
F [in]	-

NEMA 213TC Dimensions

L3 [in]	-
E [in]	-
F [in]	-