

DD-2512-A4/10XX

Call 800-321-7800 or visit us online at www.nookindustries.com to configure and order your DD-2512-A4/10XX today!

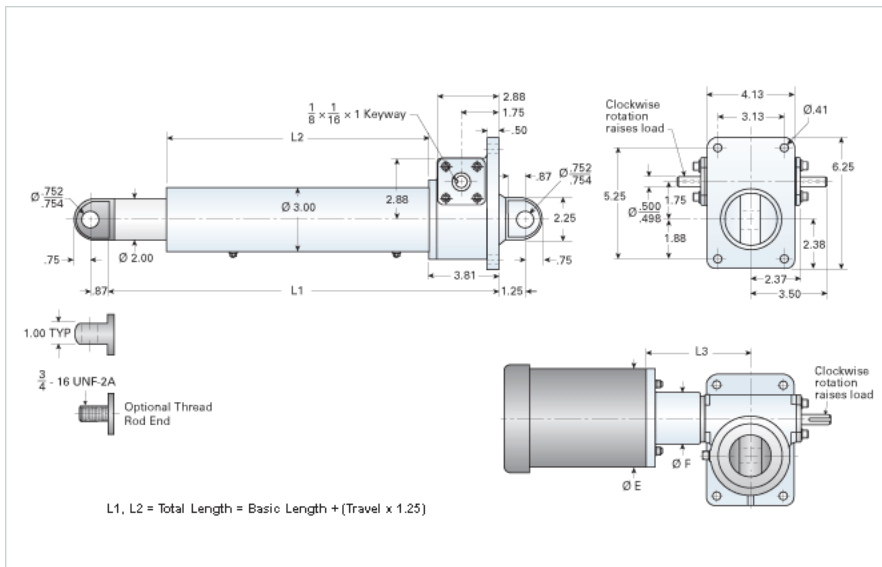

Performance Specifications

Travel Rate [in/min]	36
Dynamic Capacity [lb]	2500
Motor Horse Power (ref.) [hp]	1
Std. Brake Torque [ft-lb]	6
Approximate Stopping Distance No Load [in]	0.06
Maximum Rod Reaction Torque [in-lb]	263

Details

Gear Ratio	12:1
Input Turns Per Inch Of Travel	48
Torque To Raise 1 lb. [in-lb]	0.0148
Max Capacity [lb]	5000
Max HP [hp]	1.5

Weight

Basic Weight [lb]	30
Per Inch of Travel [lb]	1.00

Tube Dimensions

L1 Basic Length [in]	10.38
L2 Basic Length [in]	4.75

NEMA 42 Dimensions

L3 [in]	-
E [in]	-
F [in]	-

NEMA 48 Dimensions

L3 [in]	-
E [in]	-
F [in]	-

NEMA 56C Dimensions

L3 [in]	6.25
E [in]	6.62
F [in]	3.50

NEMA 182TC Dimensions

L3 [in]	-
E [in]	-
F [in]	-

NEMA 184TC Dimensions

L3 [in]	-
E [in]	-
F [in]	-

NEMA 213TC Dimensions

L3 [in]	-
E [in]	-
F [in]	-