

## RAD-3022-A4/05XX

Call 800-321-7800 or visit us online at [www.nookindustries.com](http://www.nookindustries.com) to configure and order your RAD-3022-A4/05XX today!

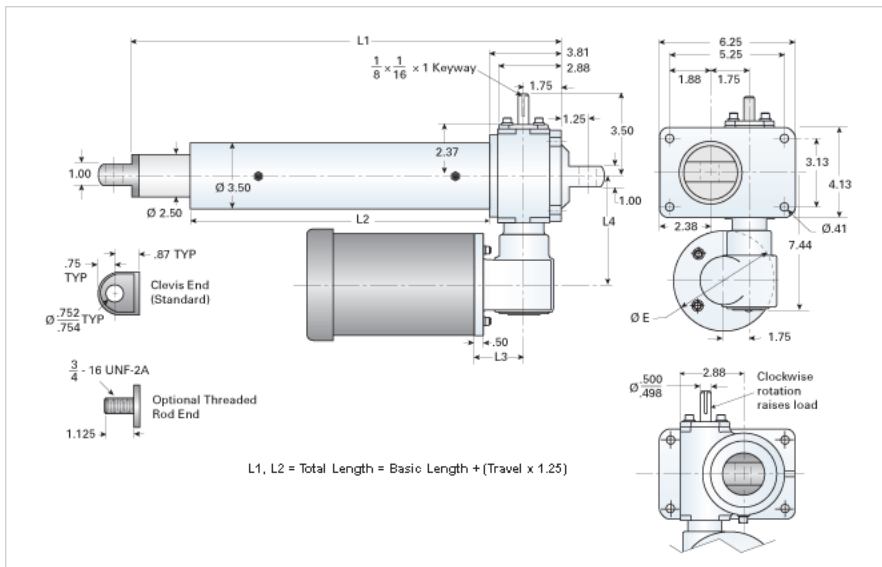

### Performance Specifications

Travel Rate [in/min]	3
Dynamic Capacity [lb]	6000
Motor Horse Power	0.5
Maximum Rod Reaction Torque [in-lb]	702
Std. Brake Torque [ft-lb]	3
Approximate Stopping Distance No Load [in]	0.004

### Details

Gear Ratio Primary Reduction	12:1
Gear Ratio Secondary Reduction	12:1
Input Turns per Inch of Travel	576
Torque to Raise 1 lb. [in-lb]	0.0025
Max Capacity [lb]	6000
Max HP [hp]	0.5

### Weight

Basic Weight [lb]	47
Per Inch of Travel [lb]	1.38

### Tube Dimensions

L1 Basic Length [in]	10.50
L2 Basic Length [in]	5.13

### NEMA 56C Dimensions

L3 [in]	3.69
L4 [in]	5.63
E [in]	6.69

### NEMA 180TC Dimensions

L3 [in]	-
L4 [in]	-
F [in]	-